



USER MANUAL *Pro Lite*

LCD Monitor

ENGLISH

DEUTSCH

FRANCAIS

NEDERLANDS

ITALIANO

POLSKI

РУССКИЙ

日本語

Pro Lite B2403WS *Pro Lite E2403WS*

Thank you very much for choosing the iiyama LCD monitor.

We recommend that you take a few minutes to read carefully through this brief but comprehensive manual before installing and switching on the monitor. Please keep this manual in a safe place for your future reference.





ENGLISH

TCO Development



Congratulations!

The display you have just purchased carries the TCO'03 Displays label. This means that your display is designed, manufactured and tested according to some of the strictest quality and environmental requirements in the world. This makes for a high performance product, designed with the user in focus that also minimizes the impact on our natural environment.

Some of the features of the TCO'03 Display requirements:

Ergonomics

- Good visual ergonomics and image quality in order to improve the working environment for the user and to reduce sight and strain problems. Important parameters are luminance, contrast, resolution, reflectance, colour rendition and image stability.

Energy

- Energy-saving mode after a certain time – beneficial both for the user and the environment
- Electrical safety

Emissions

- Electromagnetic fields
- Noise emissions

Ecology

- The product must be prepared for recycling and the manufacturer must have a certified environmental management system such as EMAS or ISO 14 001
- Restrictions on
 - o chlorinated and brominated flame retardants and polymers
 - o heavy metals such as cadmium, mercury and lead.

The requirements included in this label have been developed by TCO Development in cooperation with scientists, experts, users as well as manufacturers all over the world. Since the end of the 1980s TCO has been involved in influencing the development of IT equipment in a more user-friendly direction. Our labelling system started with displays in 1992 and is now requested by users and IT-manufacturers all over the world.

For more information, please visit
www.tcodevelopment.com



FCC DECLARATION OF CONFORMITY

Model Number: PL2400
Trade Name: iiyama
Responsible party: Ampronix Inc.
Address: 8697 Research Dr. Irvine, CA.92618 U.S.A.
Telephone number: 949-788-9930

This device complies with Part 15 of the FCC Rules. Operation is subject to the following two conditions: (1) This device may not cause harmful interference, and (2) this device must accept any interference received, including interference that may cause undesired operation.

This device has been tested and found to comply with the limits for Class B Personal Computers and peripherals, pursuant to Part 15 of the FCC Rules. These limits are designed to provide reasonable protection against harmful interference when the device is operated in a residential environment. This device generates, uses and can radiate radio frequency energy, and if not installed and used in accordance with the instructions, may cause harmful interference to radio communications. However, there is no guarantee that interference will not occur in a particular installation. If you determine the device does cause harmful interference to radio or television reception (this may be determined by monitoring the interference while turning the device off and on), you are encouraged to try to correct the interference by one of the following measures:

- Reorient or relocate the receiving antenna.
- Increase the separation between the device and receiver.
- Connect the device into an outlet on a circuit different from that to which the receiver is connected.
- Consult the dealer or an experienced radio or TV technician for help.

To meet the FCC requirements, you should use a signal cable with ferrite core at both ends.

CAUTION

Changes or modifications not expressly approved by IIYAMA could void the users authority to operate the device under FCC compliance regulations.

CANADIAN DEPARTMENT OF COMMUNICATIONS COMPLIANCE STATEMENT

This digital apparatus does not exceed the Class B limits for radio noise emissions from digital apparatus as set out in the radio interference regulation of the Canadian department of communications.

CE MARKING DECLARATION OF CONFORMITY

This LCD monitor complies with the requirements of the EC Directive 89/336/EEC "EMC Directive" and 73/23/EEC "Low Voltage Directive" as amended by Directive 93/68/EEC.

The electro-magnetic susceptibility has been chosen at a level that gives correct operation in residential areas, business and light industrial premises and small-scale enterprises, inside as well as outside of the buildings. All places of operation are characterised by their connection to the public low voltage power supply system.

- We reserve the right to change specifications without notice.
- All trademarks used in this user manual are the property of their respective owners.
- As an ENERGY STAR® Partner, iiyama has determined that this product meets the ENERGY STAR® guidelines for energy efficiency.



TABLE OF CONTENTS

FOR YOUR SAFETY	1
SAFETY PRECAUTIONS	1
SPECIAL NOTES ON LCD MONITORS	3
CUSTOMER SERVICE	3
CLEANING	3
BEFORE YOU OPERATE THE MONITOR	4
FEATURES	4
CHECKING THE CONTENTS OF THE PACKAGE	4
FITTING AND REMOVAL OF BASE	5
CONTROLS AND CONNECTORS	6
CONNECTING YOUR MONITOR	7
COMPUTER SETTING	8
ADJUSTING THE HEIGHT AND THE VIEWING ANGLE : ProLite B2403WS ..	8
ADJUSTING THE VIEWING ANGLE : ProLite E2403WS	9
PANEL ROTATION : ProLite B2403WS	9
OPERATING THE MONITOR	10
ADJUSTMENT MENU CONTENTS	11
SCREEN ADJUSTMENTS	16
POWER MANAGEMENT FEATURE	19
TROUBLE SHOOTING	20
RECYCLING INFORMATION	21
APPENDIX	22
SPECIFICATIONS : ProLite B2403WS	22
SPECIFICATIONS : ProLite E2403WS	23
DIMENSIONS : ProLite B2403WS	24
DIMENSIONS : ProLite E2403WS	24
CONNECTOR PIN ASSIGNMENT	25
COMPLIANT TIMING	25

Regulatory information : The high efficiency LCD backlights used in this product contains 5mg or less of Mercury, the disposal of which may be regulated due to environmental considerations.

For disposal or recycling information, please contact your local authorities or the Electronic Industries Alliance (www.eiae.org).

This information is only for U.S.A..

We recommend recycling of used product. Please contact your dealer or iiyama service center. Recycle information is obtained via the Internet, using the address:

<http://www.iiyama.com>

You can access the Web page of different countries from there.



FOR YOUR SAFETY

SAFETY PRECAUTIONS

WARNING

STOP OPERATING THE MONITOR WHEN YOU SENSE TROUBLE

If you notice any abnormal phenomena such as smoke, strange sounds or fumes, unplug the monitor and contact your dealer or iiyama service center immediately. Further use may be dangerous and can cause fire or electric shock.

NEVER REMOVE THE CABINET

High voltage circuits are inside the monitor. Removing the cabinet may expose you to the danger of fire or electric shock.

DO NOT PUT ANY OBJECT INTO THE MONITOR

Do not put any solid objects or liquids such as water into the monitor. In case of an accident, unplug your monitor immediately and contact your dealer or iiyama service center. Using the monitor with any object inside may cause fire, electric shock or damage.

INSTALL THE MONITOR ON A FLAT, STABLE SURFACE

The monitor may cause an injury if it falls or is dropped.

DO NOT USE THE MONITOR NEAR WATER

Do not use where water may be splashed or spilt onto the monitor as it may cause fire or electric shock.

OPERATE UNDER THE SPECIFIED POWER SUPPLY

Be sure to operate the monitor only with the specified power supply. Use of an incorrect voltage will cause malfunction and may cause fire or electric shock.

PROTECT THE CABLES

Do not pull or bend the power cable and signal cable. Do not place the monitor or any other heavy objects on the cables. If damaged, the cables may cause fire or electric shock.

ADVERSE WEATHER CONDITIONS

It is advisable not to operate the monitor during a heavy thunder storm as the continual breaks in power may cause malfunction. It is also advised not to touch the plug in these circumstances as it may cause electric shock.



CAUTION

INSTALLATION LOCATION

Do not install the monitor where sudden temperature changes may occur, or in humid, dusty or smoky areas as it may cause fire, electric shock or damage. You should also avoid areas where the sun shines directly on the monitor.

DO NOT PLACE THE MONITOR IN A HAZARDOUS POSITION

The monitor may topple and cause injury if not suitably located. Please also ensure that you do not place any heavy objects on the monitor, and that all cables are routed such that children may not pull the cables and possibly cause injury.

MAINTAIN GOOD VENTILATION

Ventilation slots are provided to keep the monitor from overheating. Covering the slots may cause fire. To allow adequate air circulation, place the monitor at least 10 cm (or 4 inches) from any walls. Do not remove the tilt stand when operating the monitor. Ventilation slots on the back of the cabinet will be blocked and the monitor may overheat if the stand is removed. This may cause fire or damage. Operating the monitor on its back, side, upside down or on a carpet or any other soft material may also cause damage.

DISCONNECT THE CABLES WHEN YOU MOVE THE MONITOR

When you move the monitor, turn off the power switch, unplug the monitor and be sure the signal cable is disconnected. If you do not disconnect them, it may cause fire or electric shock.

UNPLUG THE MONITOR

If the monitor is not in use for a long period of time it is recommended that it is left unplugged to avoid accidents.

HOLD THE PLUG WHEN DISCONNECTING

To disconnect the power cable or signal cable, always pull it by the plug. Never pull on the cable itself as this may cause fire or electric shock.

DO NOT TOUCH THE PLUG WITH WET HANDS

Pulling or inserting the plug with wet hands may cause electric shock.

WHEN YOU INSTALL THE MONITOR ON YOUR COMPUTER

Be sure the computer is strong enough to hold the weight of the monitor, otherwise, you may damage your computer.

DO NOT PUT FLOPPY DISKS NEAR THE SPEAKERS

Magnetically recorded data, such as on a floppy disk, may become corrupted by the magnetic field produced by the speakers if the disks are placed on or near the speakers.

OTHERS

ERGONOMIC RECOMMENDATIONS

To eliminate eye fatigue, do not operate the monitor against a bright background or in a dark room. For optimal viewing comfort, the monitor should be just below eye level and 40-60 cm (16-24 inches) away from your eyes. When using the monitor over a prolonged time, a ten minute break every hour is recommended as looking at the screen continuously can cause eye strain.

2 FOR YOUR SAFETY



SPECIAL NOTES ON LCD MONITORS

The following symptoms are normal with LCD monitors and do not indicate a problem.

NOTE

- When you first turn on the LCD monitor, the picture may not fit in the display area because of the type of computer that is used. In this case, adjust the picture position to the correct position.
- Due to the nature of the backlight, the screen may flicker during initial use. Turn off the Power Switch and then turn it on again to make sure the flicker disappears.
- You may find slightly uneven brightness on the screen depending on the desktop pattern you use.
- Due to the nature of the LCD screen, an afterimage of the previous screen may remain after switching the image, when the same image is displayed for hours. In this case, the screen is recovered slowly by changing the image or turning off the Power Switch for hours.
- Contact your dealer or iiyama service center for the backlight replacement when the screen is dark, flickering or not lighting up. Never attempt to replace it by yourself.

CUSTOMER SERVICE

NOTE

- The fluorescent light used in the LCD monitor may have to be periodically replaced. For the warranty coverage on this component, please check with local iiyama service center.
- If you have to return your unit for service and the original packaging has been discarded, please contact your dealer or iiyama service center for advice or replacement packaging.

CLEANING

WARNING

- If you drop any materials or liquids such as water into the monitor when cleaning, unplug the power cable immediately and contact your dealer or iiyama service center.

CAUTION

- For safety reasons, turn off the power switch and unplug the monitor before you clean it.

NOTE

- To protect the LCD panel, do not scratch or rub the screen with a hard object.
- Never use any of the following strong solvents. These will damage the cabinet and the LCD screen.

Thinner	Spray-type cleaner
Benzine	Wax
Abrasive cleaner	Acid or Alkaline solvent
- Touching the cabinet with any product made from rubber or plastic for a long time may cause degeneration or loss of paint on the cabinet.

CABINET

Stains can be removed with a cloth lightly moistened with a mild detergent solvent. Then wipe the cabinet with a soft dry cloth.

LCD

Periodic cleaning with a soft dry cloth is recommended.

SCREEN

Don't use tissue paper etc. because these will damage the LCD screen.

FOR YOUR SAFETY 3

BEFORE YOU OPERATE THE MONITOR

FEATURES

- ◆ 61.2cm (24.0") TFT Color LCD Monitor
- ◆ Supports Resolutions up to 1920 × 1200
- ◆ High Contrast 2000:1 (DCR) / Brightness 300cd/m² / Quick Response Time 2ms (Gray to Gray) : ProLite B2403WS
- ◆ High Contrast 2000:1 (DCR) / Brightness 250cd/m² / Quick Response Time 2ms (Gray to Gray) : ProLite E2403WS
- ◆ Digital Character Smoothing
- ◆ Automatic Set-up
- ◆ Stereo Speakers
2 × 2W Stereo Speakers
- ◆ Plug & Play VESA DDC2B Compliant
Windows® 95/98/2000/Me/XP/Vista Compliant
- ◆ Power Management (ENERGY STAR® VESA DPMS Compliant)
- ◆ Ergonomic Design: TCO '03 and MPR III Approved
- ◆ Digital Input (HDMI) for Clear Display
- ◆ 90° Panel Rotation Design : ProLite B2403WS
- ◆ VESA Mounting Standard (100mm×100mm) Compliant
- ◆ Keyhole for Security Lock

CHEKING THE CONTENTS OF THE PACKAGE

The following accessories are included in your package. Check to see if they are enclosed with the monitor. If anything is missing or damaged, please contact your local iiyama dealer or regional iiyama office.

- | | | |
|----------------|----------------------|------------------|
| ■ Power Cable* | ■ D-Sub Signal Cable | ■ DVI-HDMI Cable |
| ■ Audio Cable | ■ Stand | ■ User Manual |

CAUTION * The rating of the Power Cable enclosed in 120V area is 10A/125V. If you are using a power supply higher than this rating, then a power cable with a rating of 10A/250V must be used. However, all guarantees and warranties are void for any problems or damage caused by a power cable not supplied by iiyama.



FITTING AND REMOVAL OF BASE

The monitor is supplied complete with a stand. If you prefer to wall mount the monitor, please follow the instructions below to remove the stand. Be sure to include the stand with the monitor if it is necessary to return the unit.

CAUTION

- Put the monitor on a stable surface. The monitor may cause injury or damage if it falls or is dropped.
- Do not give a strong impact to the monitor. It may cause damage.
- Unplug the monitor before removal or installation to avoid electric shock or damage.

ProLite B2403WS

<Installation>

- ① Put a piece of soft cloth on the table beforehand to prevent the monitor from being scratched. Lay the monitor flat on a table with front face down.
- ② Insert stand into the monitor as shown in figure as action '2'.
- ③ To secure stand, gently lower base as shown in figure as action '3' until stand locks.

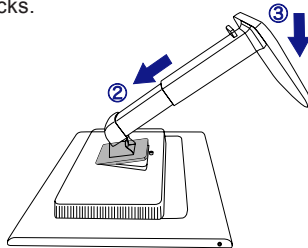

<Remove>

- ① Put a piece of soft cloth on the table beforehand to prevent the monitor from being scratched. Lay the monitor flat on a table with front face down.
- ② Press release button as shown in figure as action '2'.
- ③ Keeping release button pressed, lift base as shown in figure as action '3'.
- ④ Remove the stand.

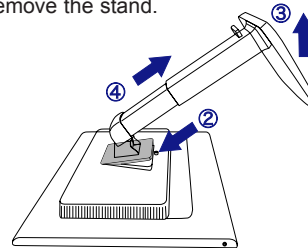

ProLite E2403WS

<Installation>

- ① Put a piece of soft cloth on the table beforehand to prevent the monitor from being scratched. Lay the monitor flat on a table with front face down.
- ② The Stand-Bottom is pulled up as shown in the figure.
- ③ Install the Stand-Base to the Stand-Bottom.

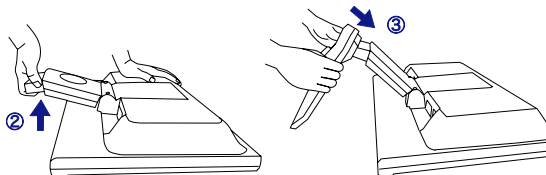

<Remove>

- ① Put a piece of soft cloth on the table beforehand to prevent the monitor from being scratched. Lay the monitor flat on a table with front face down.
- ② Hold down the hooks outside and pull the Stand-Base away from the Stand-Bottom.

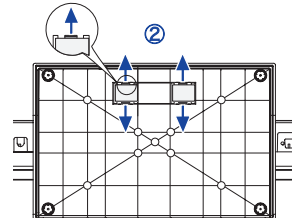

BEFORE YOU OPERATE THE MONITOR 5



CONTROLS AND CONNECTORS

ENGLISH

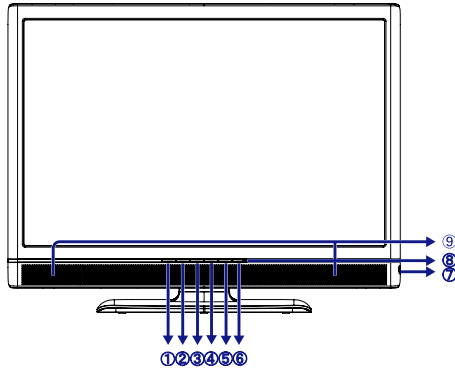

<Front>

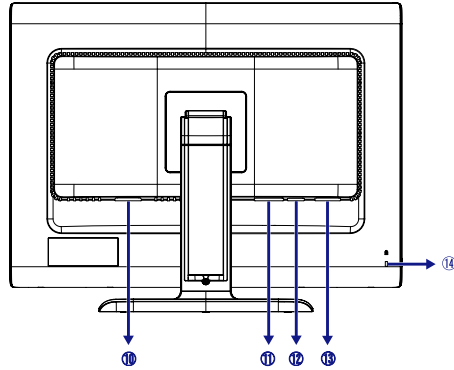

<Back>

- ① Auto Button (AUTO)
- ② Exit / Volume Button (EXIT)
- ③ Scroll Down / Contrast Button (◀)
- ④ Scroll Up / Brightness Button (▶)
- ⑤ Menu / Select Button (ENTER)
- ⑥ Power Switch (⏻)
- ⑦ Headphone Connector
- ⑧ Power Indicator

NOTE Green: Normal operation
 Orange: Power Management

The monitor enters into power management mode which reduces the power consumption to less than 2W when receiving no horizontal and/or vertical sync signal.

- ⑨ Speakers
- ⑩ AC Connector (POWER IN)
- ⑪ Audio Connector (LINE IN)
- ⑫ HDMI Connector
- ⑬ D-SUB mini 15pin Connector (D-SUB)
- ⑭ Keyhole for Security Lock

NOTE You can fasten a security lock and cable to prevent the monitor from being removed without your permission.





CONNECTING YOUR MONITOR

- ① Ensure that both the computer and the monitor are switched off.
- ② Connect the computer to the monitor with the signal cable. (See page 25 for CONNECTOR PIN ASSIGNMENT.)
- ③ Connect the monitor to the audio equipment with the Audio Cable for computer when using the audio features.
- ④ Connect the Power Cable to the monitor first and then to the power supply.

- NOTE**
- The signal cables used for connecting the computer and monitor may vary with the type of computer used. An incorrect connection may cause serious damage to both the monitor and the computer. The cable supplied with the monitor is for a standard 15 pin D-Sub connector. If a special cable is required please contact your local iiyama dealer or regional iiyama office.
 - For connection to Macintosh computers, contact your local iiyama dealer or regional iiyama office for a suitable adaptor.
 - Make sure you tighten the finger screws at each end of the signal cable.

[Example of Connection]

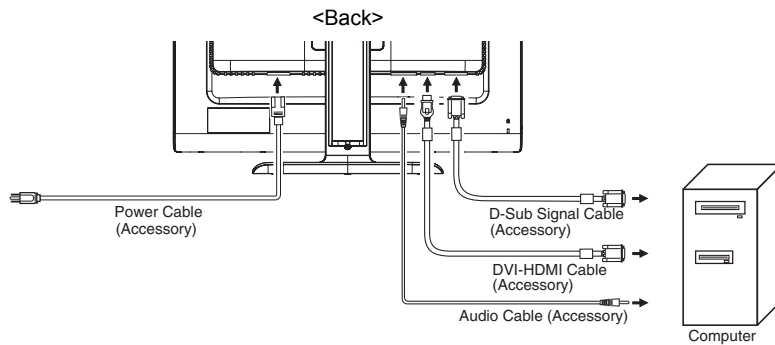

[Fitting and Removal of Cable Holder : PLE2403]

● Fitting

- ① Pull out the hook.
- ② Hold the both sides of the hook, and remove one tab at a time.

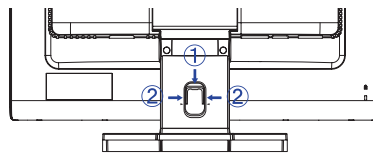

● Removal

- ① Collect cables at the back of the stand.
- ② Hold the both sides of the hook, and insert one tab at a time into the holes.

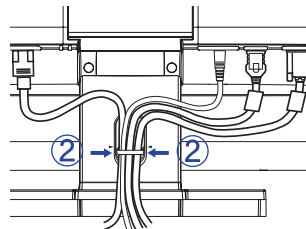

BEFORE YOU OPERATE THE MONITOR 7





COMPUTER SETTING

■ Signal Timing

Change to the desired signal timing listed on page 25: COMPLIANT TIMING.

■ Windows 95/98/2000/Me/XP/Vista Plug & Play

The iiyama LCD monitor complies with DDC2B of VESA standard. The Plug & Play function runs on Windows 95/98/2000/Me/XP/Vista by connecting the monitor to DDC2B compliant computer with the Signal Cable supplied.

For installation on Windows 95/98/2000/Me/XP: The monitor Information File for iiyama monitors may be necessary for your computer and obtained via the Internet, using the address:

<http://www.iiyama.com>

NOTE

- For additional information on how to download the driver for your touch screen monitor, please access the internet site noted above.
- Monitor Drivers are not required in most cases for Macintosh or Unix operating systems. For further information, please contact your computer dealer first for advice.

ADJUSTING THE HEIGHT AND THE VIEWING ANGLE : ProLite B2403WS

- For optimal viewing it is recommended to look at the full face of the monitor, then adjust the monitor's height and angle to your own preference.
- Hold the panel so that the monitor does not topple when you change the monitor's height or angle.
- You are able to adjust the monitor's height up to 130mm. The monitor can also be tilted up to 20° upward, 5° downward and swiveled 45° to the right and left.
- In order to ensure a healthy and relaxed body position when using the monitor at visual display workstations, it is recommended that the adjusted tilt angle should not exceed 10 degrees. Adjust the monitor's angle to your own preference.

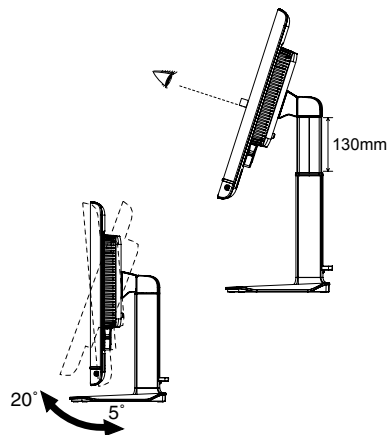

NOTE

- Do not touch the LCD screen when you change the angle. It may cause damage or break the LCD screen.
- Careful attention is required not to catch your fingers or hands when you change the angle.
- Do not tilt the post beyond 20 degrees except when repacking the monitor in its box. To do so may cause the monitor to fall over and break.

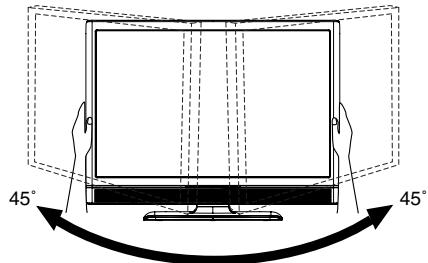

8 BEFORE YOU OPERATE THE MONITOR





ADJUSTING THE VIEWING ANGLE : ProLite E2403WS

- For optimal viewing it is recommended to look at the full face of the monitor.
- Hold the stand so that the monitor does not topple when you change the monitor's angle.
- You are able to adjust the monitor's angle up to 20° upward, 5° downward.
- In order to ensure a healthy and relaxed body position when using the monitor at visual display workstations, it is recommended that the adjusted tilt angle should not exceed 10 degrees. Adjust the monitor's angle to your own preference.

- NOTE**
- Do not touch the LCD screen when you change the angle. It may cause damage or break the LCD screen.
 - Careful attention is required not to catch your fingers or hands when you change the angle.
 - Do not tilt the post beyond 20 degrees except when repacking the monitor in its box. To do so may cause the monitor to fall over and break.

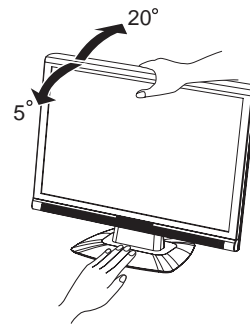
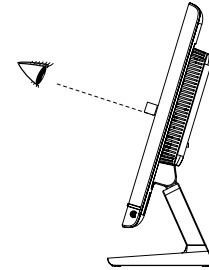

PANEL ROTATION : ProLite B2403WS

- ① Adjust the monitor's height to the maximum.
- ② Rotate the panel 90 degrees.
Portrait: Turn clockwise.
Landscape: Turn counter clockwise.
- ③ Adjust the monitor's angle to your preference.

- NOTE**
- Attempting to rotate without fully extending upward may cause damage to stand.
 - Screen Rotation should be accessed via the softOSM software.

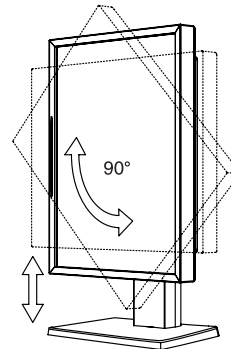

<softOSM>

The Desktop softOSM software complies with the DDC/CI standard and can be downloaded from the iiyama website.

www.iiyama.com

OPERATING THE MONITOR

To create the best picture, your iiyama LCD monitor has been preset at the factory with the COMPLIANT TIMING shown on page 25. You are also able to adjust the picture by following the button operation shown below. For more detailed adjustments, see page 16 for SCREEN ADJUSTMENTS.

- 1 Press the **ENTER** Button to start the **On Screen Display** feature. There are additional **Menu** items which can be switched by using the **◀ / ▶** Buttons.

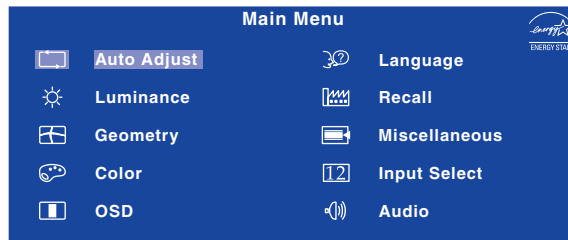

- 2 Select the **Menu** item which contains the adjustment icon relating to the adjustment you want to make. Press the **ENTER** Button. Then, use the **◀ / ▶** Buttons to highlight the desired adjustment icon.
- 3 Press the **ENTER** Button again. Use the **◀ / ▶** Buttons to make the appropriate adjustment or setting.
- 4 Press the **EXIT** Button to leave the menu, and the settings you just made would be automatically saved.

For example, to correct for vertical position, select **Menu** item of **Geometry** and then press the **ENTER** Button. Then, select **V.Position** by using the **◀ / ▶** Buttons.

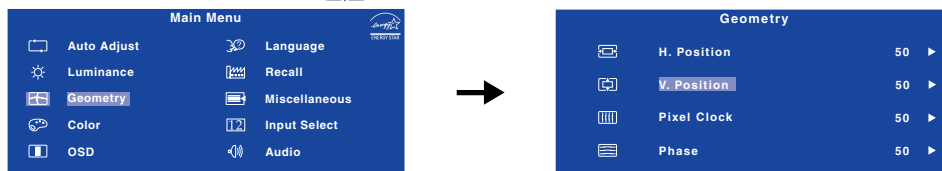

An adjustment page appears after you press the **ENTER** Button. Then, use the **◀ / ▶** Buttons to change the vertical position settings. The vertical position of the overall display should be changing accordingly while you are doing this.

Press the **EXIT** Button lastly, it ends, any changes are saved in the memory.

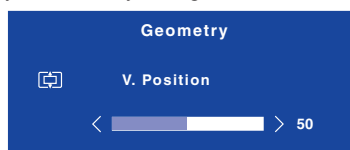

NOTE

- When button operations are aborted during adjustment, On-Screen Display disappears when the time set for the OSD Time has passed. Also, press the **EXIT** button to quickly turn off the On-Screen Display.
- Any changes are automatically saved in the memory when the On Screen Display disappears. Turning off the power should be avoided while using the Menu.
- Adjustments for H. / V. Position, Pixel Clock and Phase are saved for each signal timing. Except for these adjustments, all other adjustments have only one setting which applies to all signal timings.



ADJUSTMENT MENU CONTENTS

Auto Adjust Only Analog Input	
Adjustment Item	Problem / Option Button to Press
Auto Adjust * Direct	Adjust H. / V. Position, Pixel Clock and Phase automatically.

* For best results, use the Auto Adjust in conjunction with the adjustment pattern. See page 16 for SCREENADJUSTMENTS.

Direct

You can skip the Menu items and display an adjustment scale directly by using the following button operations.

- Auto Adjust: Press the Auto Button when the Menu is not displayed.

Luminance *1	
Adjustment Item	Problem / Option Button to Press
Brightness *2 Direct	Too dark Too bright
Contrast Direct	Too dull Too intense

*1 Luminance adjustment disabled when DCR mode is active.

*2 Adjust the Brightness when you are using the monitor in a dark room and feel the screen is too bright.



















Direct



You can skip the Menu items and display an adjustment scale directly by using the following button operations.











- Contrast: Press the Button when the Menu is not displayed.
- Brightness: Press the Button when the Menu is not displayed.



ENGLISH

 Geometry Only Analog Input		
Adjustment Item	Problem / Option	Button to Press
 H. Position	 Too left	
	 Too right	
 V. Position	 Too low	
	 Too high	
 Pixel Clock	 Too narrow	
	 Too wide	
 Phase	To correct flickering text or lines	 

 Color		
Adjustment Item	Problem / Option	Button to Press
9300K	Bluish white	
7500K	Yellowish white	
6500K	Reddish white	
User Preset	Red	
	Green	
	Blue	Too strong

 OSD		
Adjustment Item	Problem / Option	Button to Press
 H.Position	OSD is too left	
	OSD is too right	
 V.Position	OSD is too low	
	OSD is too high	
 OSD Time	You can set the OSD display duration time between 5 and 30 seconds.	 





Language				
Adjustment Item	Problem / Option		Button to Press	
Language	English	English	Polski	Polish
	Français	French	Русский	Russian
	Deutsch	German	日本語	Japanese
	Italiano	Italian	Nederlands	Dutch
	Español	Spanish	简体中文	Simplified Chinese

Recall		
Adjustment Item	Problem / Option	
Recall All	Yes	Factory-preset data is restored.
	No	Return to Menu.

ENGLISH



ENGLISH

Miscellaneous	
Adjustment Item	Problem / Option Button to Press
Sharpness	1 2 3 4 5 You can change the picture quality from 1 to 5 (sharp to soft). Press the Button to change the picture quality in numerical order. Press the Button to change the picture quality in reverse numerical order.
DDC/CI	On DDC/CI is turned ON.
	Off DDC/CI is turned OFF.
NOTE DDC/CI On and Off are switched as follows by pressing the Button successively. 	
Display Information	Displays information regarding the current input signal coming from the graphic card in your computer. NOTE See your graphic card user guide for more information about changing the resolution and refresh.
DCR	On Increased Contrast Ratio
	Off Typical Contrast Ratio
OD *1	0 1 2 3 4 5 You can set the OverDrive level between 0 and 5. It will improve the gray level response time of the LCD panel. A higher level results in a faster response time.
Display Mode *2	Full Expansion display
	1 : 1 Displayed at the same magnification
	Aspect Expansion display of Aspect

*1 OD cannot enable at the same time when Display Mode is set to 1 : 1 or Aspect, and Vertical Frequency is more than 60Hz. When OD is activated, some level of image retention will be caused. For optimal viewing, the recommended level is 3 or lower.

*2 Display Mode is locked to Full and you cannot select 1 : 1 or Aspect when receiving 1920 x 1080 signal.





12 Input Select

Adjustment Item	Problem / Option	Button to Press
12 Input Select Direct	D-sub	Select the Analog input.
	HDMI	Select the Digital input.

NOTE When only one of the two signal inputs is connected to the signal source, the one connected is automatically selected. Input Select function is not available if there is no signal input from the selected connector or during the power management mode.

Direct

You can skip the Menu items and display an adjustment scale directly by using the following button operations.

- Input Select: Press the Exit Button when the Menu is not displayed.

Audio

Adjustment Item	Problem / Option	Button to Press
Volume	Too soft	▶
	Too loud	◀
Mute	On	▶
	Off	▶

NOTE

- Mute On and Off are switched as follows by pressing the ▶ Button successively.
 [▶ On → Off]
- is displayed of AUDIO in the Main Menu while Mute is active.
- is displayed of AUDIO in the Main Menu while Mute is not active.

12 Audio Input Select	Auto Detect	Automatically detects audio input.
	Line-in	Allows manual selection of audio input.

SCREEN ADJUSTMENTS

Adjust the image by following the procedure below to get the desired picture when selecting Analog input.

- The screen adjustments described in this manual are designed to set image position and minimize flicker or blur for the particular computer in use.
- The monitor is designed to provide the best performance at resolution of 1920 × 1200, but can not provide the best at resolutions of less than 1920 × 1200 because the picture is automatically stretched to fit the full screen. It is recommended to operate at resolution of 1920 × 1200 in normal use.
- Displayed text or lines will be blurred or irregular in thickness when the picture is stretched due to the screen enlargement process.
- It is preferable to adjust the image position and frequency with the monitor controls, rather than the computer software or utilities.
- Perform adjustments after a warm-up period of at least thirty minutes.
- Additional adjustments may be required after the Auto Adjust depending on the resolution or signal timing.
- The Auto Adjust may not work correctly when displaying the picture other than the screen adjustment pattern. In this case, manual adjustments are required.

There are two ways to adjust the screen. One way is automatic adjustment for Position, Pixel Clock and Phase. The other way is performing each adjustment manually.

Perform the Auto Adjust first when the monitor is connected to a new computer, or resolution is changed. If the screen has a flicker or blur, or the picture does not fit in the display area after performing the Auto Adjust, manual adjustments are required. Both adjustments should be made by using the screen adjustment pattern (Test.bmp) obtained via the Iiyama web site (<http://www.iiyama.com>).

Adjust the image by following the procedure below to get the desired picture.
This manual explains adjustment under Windows 95/98/2000/Me/XP/Vista.

- ① Display the picture at the optimum resolution.
- ② Enter the Test.bmp (screen adjustment pattern) to wallpaper.

NOTE

- Consult the appropriate documentation for doing this.
- Test.bmp is made at resolution of 1280 × 1024. Set the display position to center in the wallpaper setting dialogue box. If you use Microsoft® PLUS! 95/98 cancel the setting of "Stretch desktop wallpaper to fit the screen".

[Adjustment pattern]

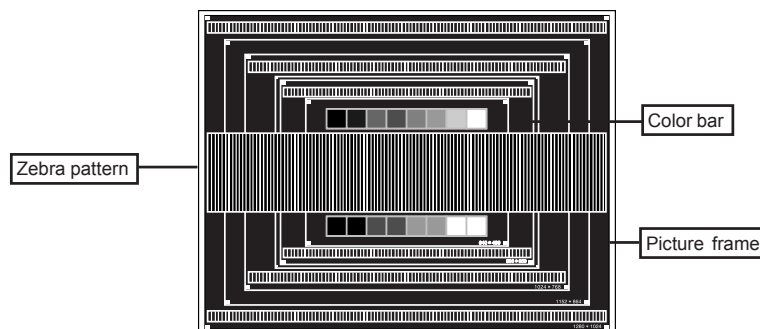



- ③ Press the Auto Button. (Auto Adjust)
- ④ Adjust the image manually by following procedure below when the screen has a flicker or blur, or the picture does not fit in the display area after performing the Auto Adjust.
- ⑤ Adjust the V.Position so that the top and bottom of the picture frame will fit to the display area.

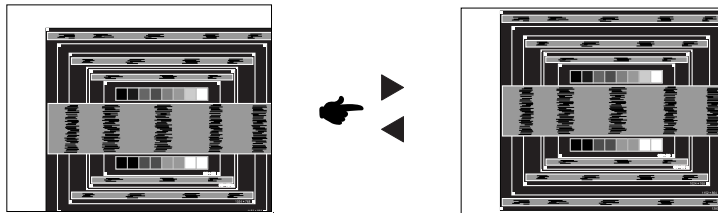

ENGLISH

- ⑥ 1) Adjust the H.Position so that the left side of the picture frame will move to the left edge of the display area.

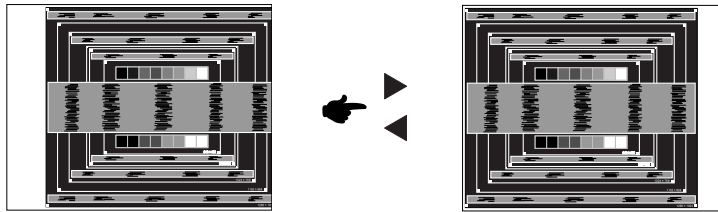

- 2) Stretch the right side of the picture frame to the right edge of the display area by adjusting the Pixel Clock.

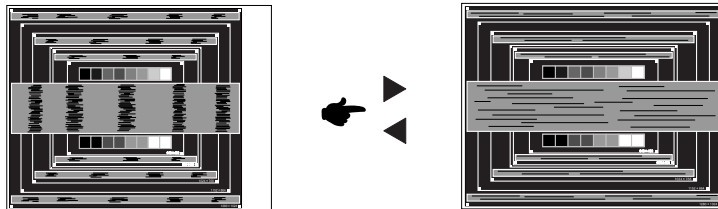

- NOTE**
- When the left side of the picture frame moves apart from the left edge of the display area during the Pixel Clock adjustment, adjust steps 1) and 2).
 - Another way to make the Pixel Clock adjustment is to correct the vertical wavy lines in the zebra pattern.
 - The picture may flicker during the Pixel Clock, H.Position and V.Position adjustment.
 - In case the picture frame is bigger or smaller than the data display area after the Pixel Clock adjustment, repeat steps from ③).





⑦ Adjust the Phase to correct horizontal wavy noise, flicker or blur in the zebra pattern.

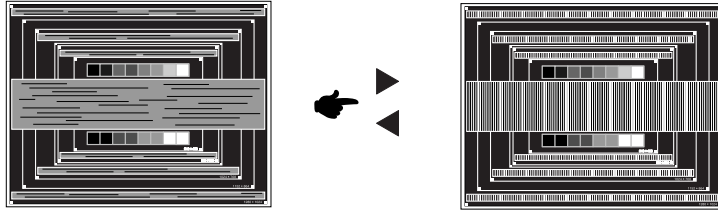

ENGLISH

NOTE

- In case the strong flicker or blurs remain on a part of the screen, repeat steps ⑥ and ⑦ because the Pixel Clock may not be adjusted correctly. If the flicker or blurs still remain, set the refresh rate of computer to low (60Hz) and repeat steps from ③ again.
- Adjust the H.Position after the Phase adjustment if the horizontal position moves during the adjustment.

⑧ Adjust the Brightness and Color to get the desired picture after you complete the Pixel Clock and Phase adjustments.
Put back your favorite wallpaper.





POWER MANAGEMENT FEATURE

The power management feature of this product complies with power saving requirement of ENERGY STAR® and VESA DPMS. When activated, it automatically reduces unnecessary power consumption of the monitor when your computer is not in use.

To use the feature, the monitor needs to be connected to a VESA DPMS compliant computer. There is a power management step the monitor takes as described below. The power management function, including any timer settings is configured by the operating system. Check your operating system manual for information on how this can be configured.

■ Power Management Mode

When the H-sync signal / V-sync signal / H and V sync signals from the computer are off, the monitor enters into Power Management Mode which reduces the power consumption to less than 2W. The screen becomes dark, and the power indicator turns to orange. From Power Management Mode, the image reappears in several seconds when either the keyboard or the mouse are touched again.

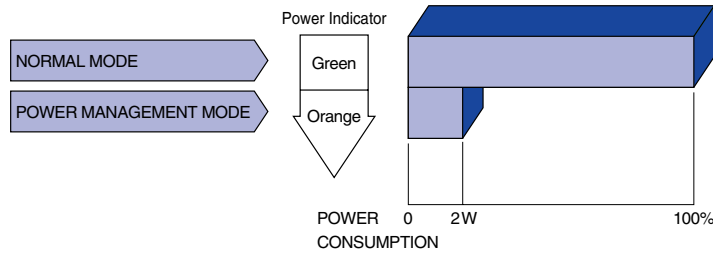

- NOTE**
- Even when using the power management mode, the monitor consumes electricity. Turn off the Power Switch whenever the monitor is not in use, during the night and weekends, to avoid unnecessary power consumption.
 - It is possible that the video signal from the computer may be on while the H or V sync signal is missing. In this instance, the POWER MANAGEMENT feature may not work properly.



TROUBLE SHOOTING

If the monitor fails to operate correctly, please follow the steps below for a possible solution.

1. Perform the adjustments described in OPERATING THE MONITOR, depending on the problem you have. If the monitor does not get a picture, skip to 2.
2. Consult the following items if you cannot find an appropriate adjustment item in OPERATING THE MONITOR or if the problem persists.
3. If you are experiencing a problem which is not described below or you cannot correct the problem, discontinue using the monitor and contact your dealer or iiyama service center for further assistance.

Problem

Check

- ① The picture does not appear.

(Power indicator does not light up.)

- The Power Cable is firmly seated in the socket.
- The Power Switch is turned ON.
- The AC socket is live. Please check with another piece of equipment.

(Power indicator is green.)

- If the blank screen saver is in active mode, touch the keyboard or the mouse.
- Increase the Contrast and/or Brightness.
- The computer is ON.
- The Signal Cable is properly connected.
- The signal timing of the computer is within the specification of the monitor.

(Power indicator is orange.)

- If the monitor is in power management mode, touch the keyboard or the mouse.
- The computer is ON.
- The Signal Cable is properly connected.
- The signal timing of the computer is within the specification of the monitor.

- ② The screen is not synchronized.

- The Signal Cable is properly connected.
- The signal timing of the computer is within the specification of the monitor.
- The video output level of the computer is within the specification of the monitor.

- ③ The screen position is not in the center.

- The signal timing of the computer is within the specification of the monitor.

- ④ The screen is too bright or too dark.

- The video output level of the computer is within the specification of the monitor.

- ⑤ The screen is shaking.

- The power voltage is within the specification of the monitor.
- The signal timing of the computer is within the specification of the monitor.



Problem

Check

- | | |
|--|--|
| <p>⑥ No sound.</p> <p>⑦ The sound is too loud or too quiet.</p> <p>⑧ A strange noise is heard.</p> | <p><input type="checkbox"/> The audio equipment (computer etc.) is ON.</p> <p><input type="checkbox"/> The Audio Cable is properly connected.</p> <p><input type="checkbox"/> The Volume is turned up.</p> <p><input type="checkbox"/> The Mute is OFF.</p> <p><input type="checkbox"/> The audio output level of the audio equipment is within the specification of the monitor.</p> <p><input type="checkbox"/> The audio output level of the audio equipment is within the specification of the monitor.</p> <p><input type="checkbox"/> The Audio Cable is properly connected.</p> |
|--|--|

ENGLISH

RECYCLING INFORMATION

For better environment protection please don't dispose your monitor.

Please visit our web site: www.iiyama.com/recycle for monitor recycling.



APPENDIX

SPECIFICATIONS : ProLite B2403WS

ENGLISH

LCD Panel	Driving system	a-Si TFT Active Matrix
	Size	Diagonal: 61.2cm / 24.0"
	Pixel pitch	0.270mm H × 0.270mm V
	Brightness	300cd/m ² (Maximum)
	Contrast ratio	1000 : 1 (Typical), 2000 : 1 (DCR)
	Viewable angle	Right / Left : 85 degrees each, Up:85 degrees, Down: 75 degrees (Typical)
	Response time	2ms (Gray to Gray)
Display Colors	Approx.16.7M (6bit+2bit dithering)	
Sync Frequency	Horizontal: 31.0-83.0kHz, Vertical: 56-75Hz	
Dot Clock	162MHz maximum	
Maximum Resolution	1920 × 1200, 2.3 MegaPixels	
Input Connector	D-Sub mini 15 pin, HDMI	
Plug & Play	VESA DDC2B™	
Input Sync Signal	Separate sync: TTL, Positive or Negative	
Input Video Signal	Analog: 0.7Vp-p (Standard), 75Ω, Positive Digital: HDMI (1.1)	
Input Audio Connector	ø 3.5mm mini jack (Stereo)	
Input Audio Signal	0.5Vrms maximum	
Speakers	2W × 2 (Stereo speakers)	
Maximum Screen Size	518.4mm W × 324.0mm H / 20.4" W × 12.8" H	
Power Source	100-240VAC, 50/60Hz, 1.5A	
Power Consumption	65W maximum, Power management mode: 2W maximum*	
Dimensions / Net Weight	566.0× 445.0-575.0 × 220.0mm / 22.3 × 17.5-22. 6× 8.7" (W×H×D), 8.7kg / 19.2lbs	
Tilt Angle	Upward: 20 degrees Downward: 5 degrees Right / Left : 45 degrees each	
Environmental Considerations	Operating: Temperature 5 to 35°C / 41 to 95°F Humidity 10 to 80% (No condensation) Storage: Temperature -20 to 60°C / -4 to 140°F Humidity 10 to 70% (No condensation)	
Approvals	TCO '03, CE, TÜV-GS / MPR III (prEN50279) / ISO 13406-2, FCC-B, UL / C-UL, VCCI-B, GOST-R	

NOTE * Condition: Audio equipment is not connected.



SPECIFICATIONS : ProLite E2403WS

LCD Panel	Driving system	a-Si TFT Active Matrix
	Size	Diagonal: 61.2cm / 24.0"
	Pixel pitch	0.270mm H × 0.270mm V
	Brightness	250cd/m ² (Typical)
	Contrast ratio	1000 : 1 (Typical), 2000 : 1 (DCR)
	Viewable angle	Right / Left : 85 degrees each, Up:85 degrees, Down: 75 degrees (Typical)
	Response time	2ms (Gray to Gray)
Display Colors	Approx.16.7M (6bit+2bit dithering)	
Sync Frequency	Horizontal: 31.0-83.0kHz, Vertical: 56-75Hz	
Dot Clock	162MHz maximum	
Maximum Resolution	1920 × 1200, 2.3 MegaPixels	
Input Connector	D-Sub mini 15 pin, HDMI	
Plug & Play	VESA DDC2B™	
Input Sync Signal	Separate sync: TTL, Positive or Negative	
Input Video Signal	Analog: 0.7Vp-p (Standard), 75Ω, Positive Digital: HDMI (1.1)	
Input Audio Connector	ø 3.5mm mini jack (Stereo)	
Input Audio Signal	0.5Vrms maximum	
Speakers	2W × 2 (Stereo speakers)	
Maximum Screen Size	518.4mm W × 324.0mm H / 20.4" W × 12.8" H	
Power Source	100-240VAC, 50/60Hz, 1.5A	
Power Consumption	65W maximum, Power management mode: 2W maximum*	
Dimensions / Net Weight	566.0×458.5 × 191.5mm / 22.3 × 18.1 × 7.5" (W×H×D), 6.5kg / 14.3lbs	
Tilt Angle	Upward: 20 degrees Downward: 5 degrees	
Environmental Considerations	Operating: Temperature	5 to 35°C / 41 to 95°F
	Humidity	10 to 80% (No condensation)
Storage:	Temperature	-20 to 60°C / -4 to 140°F
	Humidity	10 to 70% (No condensation)
Approvals	TCO '03, CE, TÜV-GS / MPR III (prEN50279) / ISO 13406-2, FCC-B, UL / C-UL, VCCI-B, GOST-R	

ENGLISH

NOTE * Condition: Audio equipment is not connected.



DIMENSIONS : ProLite B2403WS

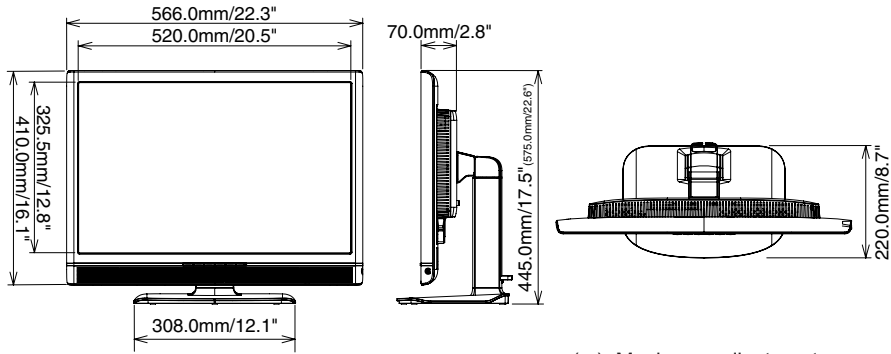

ENGLISH

(): Maximum adjustment range

DIMENSIONS : ProLite E2403WS

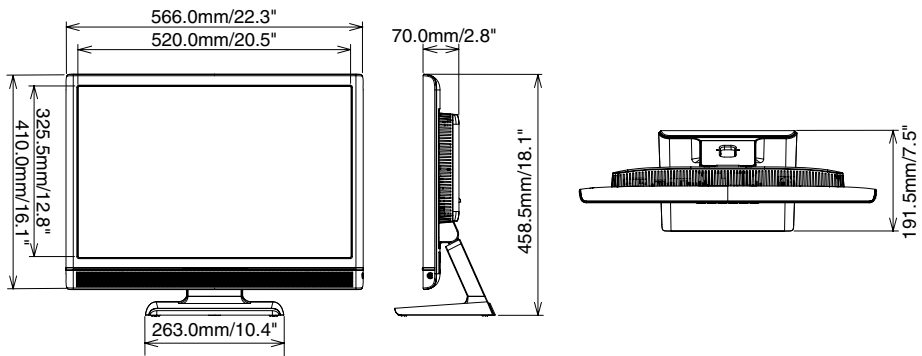



CONNECTOR PIN ASSIGNMENT

- D-Sub mini 15pin Connector

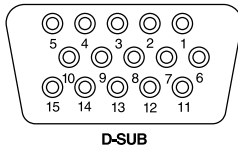

Pin	Input Signal	Pin	Input Signal
1	Red video	9	+5V
2	Green video	10	Ground
3	Blue video	11	NC
4	NC	12	Data line (SDA)*
5	Ground	13	H-Sync
6	Red video ground	14	V-Sync
7	Green video ground	15	Clock line (SCL)*
8	Blue video ground		

* Compliant to VESA DDC.

ENGLISH

COMPLIANT TIMING PC Input

Video Mode		Horizontal Frequency	Vertical Frequency	Dot Clock	
VESA	VGA 640 × 480	31.469kHz	59.940Hz	25.175MHz	
		37.500kHz	75.000Hz	31.500MHz	
		37.861kHz	72.809Hz	31.500MHz	
	SVGA 800 × 600	37.879kHz	60.317Hz	40.000MHz	
		46.875kHz	75.000Hz	49.500MHz	
		48.077kHz	72.188Hz	50.000MHz	
	XGA 1024 × 768	48.363kHz	60.004Hz	65.000MHz	
		56.476kHz	70.069Hz	75.000MHz	
		60.023kHz	75.029Hz	78.750MHz	
	WXGA 1280 × 768	47.396kHz	60.000Hz	68.250MHz	
		47.776kHz	59.870Hz	79.500MHz	
		60.289kHz	74.893Hz	102.250MHz	
	SXGA	1152 × 864	67.500kHz	75.000Hz	108.000MHz
			63.981kHz	60.020Hz	108.000MHz
		1280 × 1024	75.830kHz	71.530Hz	128.000MHz
			79.976kHz	75.025Hz	135.000MHz
	WXGA+ 1440 × 900	55.935kHz	59.887Hz	106.500MHz	
		70.635kHz	74.984Hz	136.750MHz	
UXGA 1600 × 1200	75.000kHz	60.000Hz	162.000MHz		
WSXGA+ 1680 × 1050	65.290kHz	60.000Hz	146.250MHz		
WUXGA 1920 × 1200	74.038kHz	59.950Hz	154.000MHz		
VGA TEXT	640 × 350	31.469kHz	70.087Hz	25.175MHz	
	720 × 400	31.469kHz	70.087Hz	28.322MHz	

NOTE *1 DVI input is not compliant.

*2 Video Input : 480p / 720p / 1080i / 1080p

APPENDIX 25
M021B01



